

Scattering Meter

ECO BB

User's Guide

This user's guide is an evolving document. If you find sections that are unclear or missing information, please let us know. Please check our website periodically for updates.

WET Labs, Inc.
PO Box 518
Philomath, OR 97370
(541) 929-5650
www.wetlabs.com

Return Policy for Instruments with Anti-fouling Treatment

WET Labs cannot accept instruments for servicing or repair that are treated with anti-fouling compound(s). This includes but is not limited to tri-butyl tin (TBT), marine anti-fouling paint, ablative coatings, etc.

Please ensure any anti-fouling treatment has been removed prior to returning instruments to WET Labs for service or repair.

ECO Sensor Warranty

This unit is guaranteed against defects in materials and workmanship for one year from the original date of purchase. Warranty is void if the factory determines the unit was subjected to abuse or neglect beyond the normal wear and tear of field deployment, or in the event the pressure housing has been opened by the customer.

To return the instrument, contact WET Labs for a Return Merchandise Authorization (RMA) and ship in the original container. WET Labs is not responsible for damage to instruments during the return shipment to the factory. WET Labs will supply all replacement parts and labor and pay for return via 3rd day air shipping in honoring this warranty.

Shipping Requirements

1. Please retain the original plastic shipping case. It meets stringent shipping and insurance requirements, and protects your meter.
2. Service and repair work cannot be guaranteed unless the meter is shipped in its original case.
3. Clearly mark the RMA number on the outside of your case and on all packing lists.
4. Return instruments using 3rd day air shipping or better: do **not** ship via ground.

Table of Contents

1. Specifications	3
1.1 Connectors.....	4
1.2 Delivered Items	4
1.3 Optional Equipment.....	5
2. Theory of Operation	8
3. Instrument Operation	9
3.1 Initial Checkout.....	9
3.2 Operating the Sensor for Data Output	9
3.3 <i>Bio-wiper</i> [™] Operation.....	10
3.4 Deployment.....	10
3.5 Upkeep and Maintenance	10
4. Using Internal Batteries	13
4.1 Removing End Flange and Batteries	13
4.2 Replacing End Flange and Batteries	14
4.3 Checking Vent Plug.....	14
5. Data Analysis	17
5.1 Data Corrections	17
5.2 Derived Parameters	18
6. Calibration and Testing.....	19
6.1 Calibration	19
6.2 Testing	20
7. Terminal Communications.....	21
7.1 Interface Specifications	21
7.2 Command List	21
8. Device Files.....	23
8.1 Plot Header	23
8.2 Column Count Specification.....	23
8.3 Column Description.....	23
8.4 Sample Device Files	24
8.5 Sample Output Files.....	24
Appendix A: Mounting Bracket Drawing	25

1. Specifications

Model	BB(RT)	BBD	BB	BBB	BBS	BBSB
Mechanical						
<i>Diameter</i>	6.3 cm					
<i>Length</i>	12.7 cm	17.8 cm	12.7 cm	25.4 cm	13.3 cm	26.0 cm
<i>Weight in air</i>	0.4 kg	1.3 kg	0.4 kg	0.96 kg	0.5 kg	0.96 kg
<i>Weight in water</i>	0.02 kg	0.75 kg	0.02 kg	0.14 kg	0.08 kg	0.14 kg
<i>Material</i>	Acetal copolymer	Titanium	Acetal copolymer			
Environmental						
<i>Temperature range</i>	0–30 deg C					
<i>Depth rating</i>	600 m	6000 m	600 m		300 m	
<i>Optional pressure sensor</i>	No	No	Yes		Yes	
<i>Optional thermistor</i>	No	No	Yes		Yes	
Electrical						
<i>Digital output resolution</i>	14 bit					
<i>Analog output signal</i>	0–5 V					
<i>Internal data logging</i>	No			Yes		
<i>Internal batteries</i>	No			Yes	No	Yes
<i>Connector</i>	MCBH6M					
<i>Input</i>	7–15 VDC					
<i>Current, typical</i>	80 mA					
<i>Current, sleep</i>	--	85 μ A	--	85 μ A		
<i>Data memory</i>	--			90,000 samples		
<i>Sample rate</i>	to 8 Hz					
<i>RS-232 output</i>	19200 baud					
<i>Bio-wiper™</i>	No				Yes	
<i>Bio-wiper™ cycle</i>	--				140 mA	
Optical						
<i>Wavelength</i>	470, 532, or 650 nm					
<i>Sensitivity, blue</i>	$1.2 \times 10^{-5} \text{ m}^{-1} \text{ sr}^{-1}$					
<i>Sensitivity, green</i>	$7.7 \times 10^{-6} \text{ m}^{-1} \text{ sr}^{-1}$					
<i>Sensitivity, red</i>	$3.8 \times 10^{-6} \text{ m}^{-1} \text{ sr}^{-1}$					
<i>Range, typical</i>	$\sim 0.0024\text{--}5 \text{ m}^{-1}$					
<i>Linearity</i>	99% R^2					

BB(RT)—Provides analog or RS-232 serial output with 4,000-count range. This unit operates continuously when power is supplied.

BBD—Provides the capabilities of the BB(RT) with 6,000-meter depth rating.

BB—Provides the capabilities of the BB(RT) with data logging.

BBB—Provides the capabilities of the BB with internal batteries for autonomous operation.

BBS—Provides the capabilities of the BB with an integrated anti-fouling *Bio-wiper™*.

BBSB—Provides the capabilities of the BBS with internal batteries for autonomous operation.

1.1 Connectors

ECO-BB instruments use a six-pin bulkhead connector as shown below.

Pin	Function
1	Ground
2	RS-232 RX
3	Reserved
4	V +
5	RS-232 TX
6	Analog out

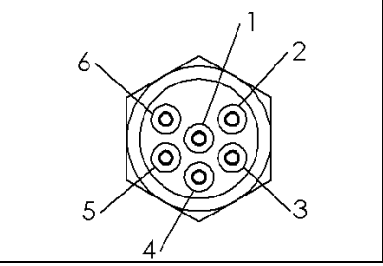

WARNING!

If you are going to build or use a non-WET Labs-built cable, do not use the wire from pin 3 or the *ECO* meter will be damaged.

Input power of 7–15 VDC is applied to pin 4. The power supply current returns through the common ground pin. The input power signal has a bi-directional filter. This prevents external power supply noise from entering into *ECO*-BB, and also prevents internally generated noise from coupling out on to the external power supply wire. Note that the power supply and the analog output share a common ground. The BBD (deep) mechanical case is floating; it is not connected to the ground.

1.1.1 *ECO* BBB and BBSB Connectors

ECO BBB and BBSB (units with internal batteries) have an second bulkhead connector that comes with a jumper plug to supply power to the unit. The contact functions for this connector are shown below.

Socket	Function
1	V +
2	N/C
3	Battery out

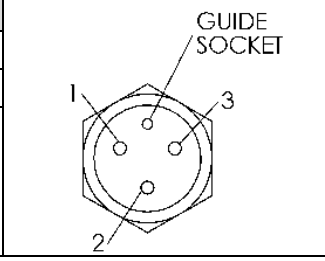

1.2 Delivered Items

The standard *ECO* delivery consists of the following:

- the instrument itself
- protective cover for optics
- dummy plug with lock collar
- this user's guide
- *ECO*View user's guide
- *ECO*View host program and device file
- instrument-specific calibration sheet

- BB(RT), BB, BBS: stainless steel mounting bracket and hardware (See Appendix A for details)

Spare parts

- One 3/32-in. hex key for *Bio-wiper*[™] removal (units with *Bio-wiper*[™] only)
- Three 4-40 x 3/8 in. 316 stainless steel replacement screws (units with *Bio-wiper*[™] only)
- Six 9-V Lithium batteries (installed) (units with internal batteries only)

Additional spare parts kit for battery units:

- Two end flange O-rings (size 224)
- Two vent plug O-rings (size 010)
- Two jacking screws for connector flange removal
- One 3/32-in. hex key for jacking screws
- Power plug for autonomous operation
- Three pre-cut segments (7 in.) of 0.036-in. diameter monofilament for end flange
- Three pre-cut segments (0.25 in.) of 0.094-in. diameter white nylon bar stock for replacing the white plastic dowel pin.

1.3 Optional Equipment

1.3.1 Test Cable

A test cable is optionally available with each unit. This cable includes three legs:

1. An RCA connector for providing an analog output.
2. A DB-9 serial interface connector.
3. A six-socket in-line connector for providing power and signal to the instrument.

1.3.2 Copper Faceplate

ECO meters are optionally equipped with copper faceplates to improve the meter's resistance to biofouling. Refer to Section 3.5.1 for important details on maintenance and cleaning.

1.3.3 *Bio-wiper*[™] and Copper Faceplate

The BBS and BBSB are equipped with an integrated non-contact anti-fouling *Bio-wiper*[™] and copper faceplate for use in extended deployments. This wiper can be manually controlled by a host controller package, or can perform autonomously as part of a pre-programmed sampling sequence upon instrument power-up. The rate of opening and closing depends on both temperature and depth. Refer to Section 3.5.1 for important details about maintaining and cleaning the *Bio-wiper*[™] and copper faceplate.

WARNING!

Do **NOT** rotate the *Bio-wiper*[™] manually. This can damage the wiper motor and will void the warranty.

1.3.4 Batteries

ECO units with internal batteries are supplied with six 9-volt Lithium batteries as their power source. They can use either standard alkaline cells for a total capacity of approximately 1000 mA-hrs, or for longer deployments, LiMnO₂ cells to achieve more than 2000 mA-hrs of operational capacity. Actual total usage time of the internal batteries is a function of several parameters. These include nominal water temperature, sequence timing, sample periods, and total deployment duration.

For even greater deployment capability contact WET Labs for information on external battery packs.

1.3.5 External Thermistor

ECO meters are optionally equipped with an external thermistor. The thermistor is calibrated at WET Labs and the calibration coefficients are supplied on the instrument's calibration sheets. Thermistor output is in counts and can be converted into engineering units using the instrument's device file and ECOView software or the raw data can be converted in the user's software (e.g. MATLAB or Excel) using the calibration equation:

$$\text{Temperature (deg C)} = (\text{Output} * \text{Slope}) + \text{Intercept}$$

1.3.6 Pressure Sensor

ECO meters are optionally equipped with a strain gauge pressure sensor. The pressure sensor is calibrated at WET Labs and the calibration coefficients are supplied on the instrument's calibration sheets. Pressure sensor output is in counts and can be converted into engineering units using the instrument's device file and ECOView software or the raw data can be converted in the user's software (e.g. MATLAB or Excel) using the calibration equation:

$$\text{Relative Pressure (dbar)} = (\text{Output} * \text{Slope}) + \text{Intercept}$$

Please note that strain gauge pressure sensors are susceptible to atmospheric pressure changes and should be "zeroed" on each deployment or profile. The calibration equation for pressure above should be used first to get the relative pressure and the cast offset should then be subtracted to get the absolute pressure:

$$\text{Absolute Pressure (dbar)} = \text{Relative Pressure (dbar)} - \text{Relative Pressure at Atmospheric/Water interface (dbar)}$$

WARNING!

Do not exceed the pressure sensor's depth rating (see calibration sheet).

Pressure Sensor Maintenance

A plastic fitting filled with silicone oil provides a buffer between the pressure transducer and seawater. The transducer is both sensitive and delicate. Following the procedures below will ensure the best results and longest life from your pressure sensor.

Pressure is transmitted from the water to the stainless steel transducer diaphragm via a plastic fitting filled with silicone oil. The inert silicone oil protects the pressure sensor

from corrosion, which would occur after long exposure to salt water. The fitting will generally prevent the oil from escaping from the reservoir into the water. However, you may occasionally wish to ensure that oil remains in the reservoir on top of the transducer.

WARNING!

Never touch or push on the transducer.

1. Thoroughly clean the top of the instrument.
 2. Completely remove the white nylon Swagelock fitting using a 9/16-in. wrench.
 3. Check for obstructions in the tiny hole. Blow clear with compressed air or use a small piece of wire.
 4. Wipe clean the O-ring at the base of the Swagelock fitting.
 5. Screw the Swagelock fitting into the end flange until finger tight.
 6. Tighten it an additional 1/8 turn using a wrench only if necessary.
 7. Wipe up any excess oil.
-

2. Theory of Operation

The *Environmental Characterization Optics*, or *ECO* miniature scattering meter allows the user to measure scattering at 117 degrees. This angle was determined as a minimum convergence point for variations in the volume scattering function induced by suspended materials and water itself. Therefore, the signal measured by this meter is less determined by the type and size of materials in the water and more directly correlated to the concentration of the materials.

The *ECO* uses one LED (modulated at 1 kHz) source light. The source light enters the water volume and scattered material is detected by a detector positioned where the acceptance angle forms a 117-degree intersection with the source beam. The figure below shows the optical configuration for the *ECO-BB*.

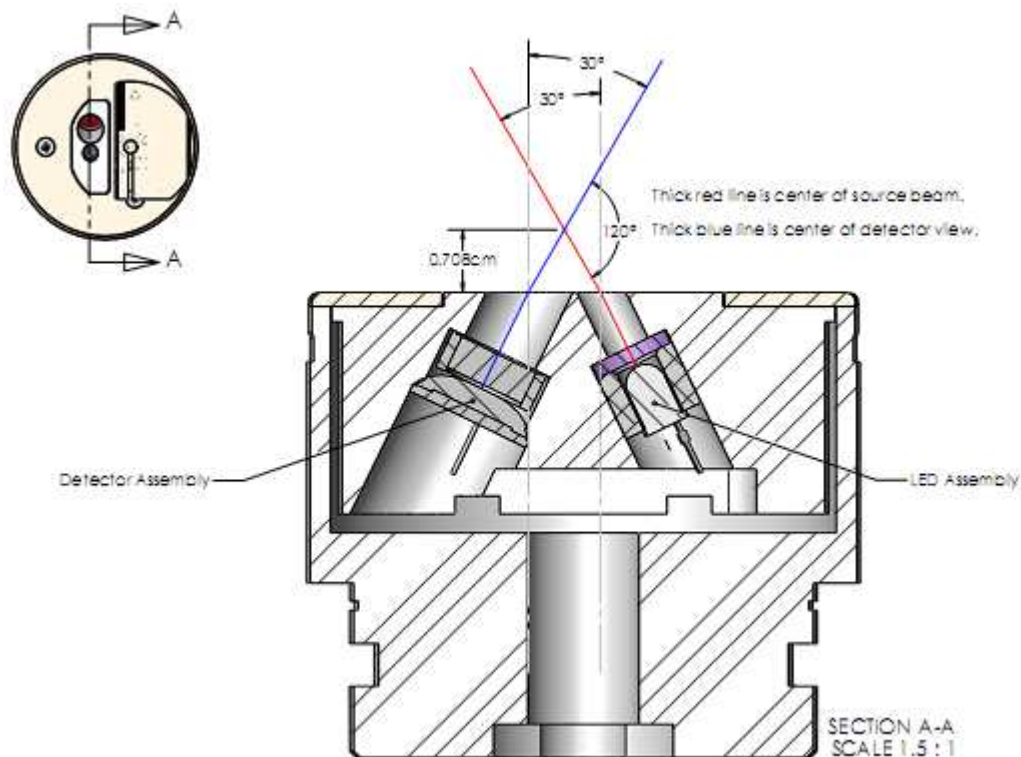

Optical configuration of *ECO* scattering meter

3. Instrument Operation

Please note that certain aspects of instrument operation are configuration-dependent. These are noted where applicable within the manual.

3.1 Initial Checkout

Supplied from the factory, *ECOs* are configured to begin continuously sampling upon power-on. Electrical checkout of *ECO* is straightforward.

WARNING!

Always use a regulated power supply to provide power to ECO sensors if not using a 9V battery. Power spikes may damage the meter.

Connect the 6-socket connector on the test cable to the instrument to provide power to the LEDs and electronics (see Section 1 for a diagram of the pin-outs of *ECO-BB*). Connect the battery leads on the test cable to a regulated power supply or a 9V battery. Light should emanate from the meter.

3.1.1 Analog Option

Connect a digital multimeter (DMM) to the auxiliary leg of the test cable: the center of the RCA connector provides analog out signal and the outside provides ground. With the sensor face clean and dry the instrument should read approximately 0.050–0.095 VDC. The analog signal will saturate at approximately 5 volts.

3.2 Operating the Sensor for Data Output

1. Connect the 6-socket connector to the instrument to provide power to the LEDs and electronics. Connect the DB-9 connector to a computer with the ECOView host program installed on it.
2. Start ECOView. Select the appropriate COM Port and Device File. Supply power to the meter. Output will appear in the Raw Data window.
3. Test the instrument's signal using the protective cap: with the cap on, the signal will increase toward saturation (maximum value on characterization sheet). Remove the cap and check the output.
 - When applying power to sensors with a *Bio-wiper*TM, the wiper will open and, depending on the settings, operate until you select **Stop Data** in ECOView (or input ! ! ! ! ! in a terminal program). The *Bio-wiper*TM will close and the instrument will await the next command.

If the sensor completes the requested samples (this is common for meters set up in moored applications), it will go into sleep mode, and the meter will not light when power is cycled. To “wake” the meter, click **Stop Data** five times at the rate of two times per second immediately upon applying power. This interrupts the sensor, returning it to a “ready” state, awaiting commands.

4. Check the settings for the ECO and change if necessary. ECOView factory settings for continuous operation:
 - Set Number of Samples = 0
 - Set Number of Cycles = 0.
5. If the meter does not light after performing step 3, check the power supply. Perform steps 2 and 3 to verify communication. If it still does not light, contact WET Labs.

Refer to the ECOView User's Guide for details about using the software.

3.3 *Bio-wiper*[™] Operation

The *ECO*-BBS and –BBSB have an anti-fouling *Bio-wiper*[™] and faceplate that extend the possible deployment duration by retarding biological growth on the instrument's optical surface. The *Bio-wiper*[™] covers the optical surface: 1) while the instrument is in "sleep" mode; 2) when it has completed the number of samples requested; and 3) when the user selects **Stop Data** in ECOView or types "!!!!" in a terminal program. When the meter wakes up, the optical surface is exposed by the *Bio-wiper*'s[™] counter-clockwise rotation.

If power is shut off in mid cycle, the *Bio-wiper*[™] will reinitialize to the beginning of the user-selected settings when power is applied again.

WARNING!

Do **NOT** rotate the *Bio-wiper*[™] manually. This can damage the wiper motor and will void the warranty.

3.4 Deployment

The *ECO* scattering meter requires no pump to assure successful operation. Once power is supplied, the unit is ready for submersion and subsequent measurements. Some consideration should be given to the package orientation. Do not face the sensor directly into the sun or other bright lights. For best output signal integrity, locate the instrument away from significant EMI sources.

Caution

The meter should be mounted so that the LED source will not "see" any part of a cage or deployment hardware. This will affect the sensor's output.

Other than these basic considerations, one only needs to make sure that the unit is securely mounted to whatever lowering frame is used and that the mounting brackets are not damaging the unit casing. The instrument can be used in a moored or profiling mode.

3.5 Upkeep and Maintenance

We highly recommend that *ECO* meters be returned to the factory annually for cleaning, calibration and standard maintenance. Contact WET Labs or visit our website for details on returning meters and shipping.

After each cast or exposure of the instrument to natural water, flush with clean fresh water, paying careful attention to the sensor face. Use soapy water to cut any grease or oil accumulation. Gently wipe clean with a soft cloth. The sensor face is composed of ABS plastic and optical epoxy and can easily be damaged or scratched.

WARNING!

Do not use acetone or other solvents to clean the sensor.

3.5.1 *Bio-wiper*TM and Faceplate Cleaning and Maintenance

The *Bio-wiper*TM and the copper faceplate need to be removed from the meter for thorough cleaning to maximize anti-fouling capability.

1. Be sure the meter is **NOT** powered or connected to a power source prior to uninstalling the *Bio-wiper*TM and faceplate.

WARNING!

Manually turning the motor shaft can damage the wiper motor and will void the warranty.

Make sure the *Bio-wiper*TM is loosened from the shaft before attempting to rotate the *Bio-wiper*TM.

2. Remove *Bio-wiper*TM: Use the factory-supplied 3/32-in. hex key to loosen the screw that secures the wiper to the shaft on the instrument. It may be necessary to remove the screw from the clamping hole and screw it into the releasing hole, tightening it just enough to free the *Bio-wiper*TM from the shaft.

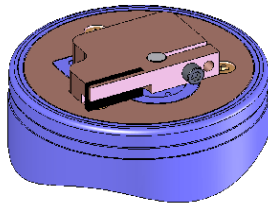

clamping screw hole

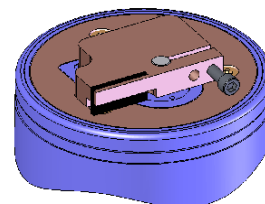

releasing screw hole

3. Remove faceplate: Use a small Phillips screwdriver to remove the screws that attach the plate to the optics head.

WARNING!

Be sure to retain and re-use the factory-installed screws as they are vented for pressure compensation.

4. Wash *Bio-wiper*TM and/or copper faceplate with soapy water. Rinse and dry thoroughly. Note the condition of the copper on the instrument side of the wiper. It is normal for copper to corrode and turn green, especially after the instrument

has been removed from the water. This corrosion will slightly reduce the shutter's anti-fouling ability the next time it is deployed.

5. Buff each with a pad of green Scotch Brite[®] (or similar) until shiny.
6. Clean the *Bio-wiper*[™] shaft and the shaft hole using an isopropyl alcohol-saturated cotton swab. Allow to dry; re-install faceplate.
7. Check the screw used to secure the *Bio-wiper*[™] to the shaft: a hex key must fit snugly into the screw socket. If the socket is in any way compromised, use a new screw (4-40 x 3/8 in. 316 stainless steel treated with anti-seize. These are shipped as part of the meter's spare parts kit.)
9. Slide the *Bio-wiper*[™] over the shaft. Be careful not to twist it on, thus rotating the shaft. If the wiper does not slide on easily, insert the screw into the expander hole, turning slowly until it slides easily onto the shaft.
10. Rotate the *Bio-wiper*[™] into the closed position.

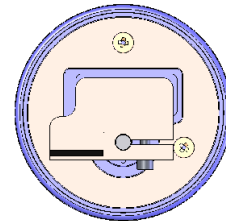

11. Set the gap between the *Bio-wiper*[™] and the instrument face to 0.03 in. (0.8 mm). An improperly set gap will either fail to clean the face or cause the motor to draw excessive current.

To gauge 0.03 in., fold a piece of paper in half, then in half again, then fold a third time, creasing the edges. It's now 8 sheets and about 0.03 in. thick.

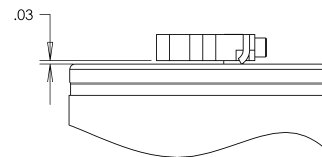

12. Use the 3/32-in. hex key to tighten the screw to “finger-tight,” then snug an additional quarter-turn.
13. Run the instrument to verify operation. The *Bio-wiper*[™] must rotate 180 degrees to clear the optics before sampling, and 180 degrees to cover the optics after sampling.
14. If the wiper needs adjusting, loosen the screw, make any necessary adjustments, and repeat steps 9 through 13 to ensure the wiper is performing properly.

4. Using Internal Batteries

ECO sensors powered with internal batteries can either run directly from the internal batteries or can operate from power supplied by an external DC power supply (7–15 volts). Internal-to-external source conversion is facilitated by a jumper plug that plugs into the unit's bulkhead connector. When inserted, the plug forms a connection from the battery to the electronics power supply. By removing the plug, the instrument can be powered and communicate via a test or deployment cable. Setup conditions, instrument checkout, real-time operation, and data downloading are thus all achieved identically to the methods prescribed for the standard unit.

4.1 Removing End Flange and Batteries

WARNING!

Changing the batteries will require opening the pressure housing of the ECO sensor. Only people qualified to service underwater oceanographic instrumentation should perform this procedure. If this procedure is performed improperly, it could result in catastrophic instrument failure due to flooding or in personal injury or death due to abnormal internal pressure as a result of flooding.

WET Labs Inc. disclaims all product liability from the use or servicing of this equipment. WET Labs Inc. has no way of controlling the use of this equipment or of choosing qualified personnel to operate it, and therefore cannot take steps to comply with laws pertaining to product liability, including laws that impose a duty to warn the user of any dangers involved with the operation and maintenance of this equipment. Therefore, acceptance of this equipment by the customer shall be conclusively deemed to include a covenant by the customer to defend and hold WET Labs Inc. harmless from all product liability claims arising from the use and servicing of this equipment. Flooded instruments will be covered by WET Labs Inc. warranties at the discretion of WET Labs, Inc.

1. Make sure the instrument is thoroughly dry. Remove the dummy plugs.
2. With connector end flange pointed downward away from face, release seal from vent plug.
3. Remove moisture from vent plug area.
4. Using needle-nose pliers, remove filament from end flange.
5. Lift flange from pressure housing until seal is broken. The jacking screws can be used to “push” the flange from the pressure housing and then can be removed or left in the end flange.
6. Remove any excess moisture from flange–can seal area.
7. Work end flange out of pressure housing and remove any residual moisture. Remove the gray foam spacer and the neoprene insulator.
8. The battery pack is connected to the processor boards by a six-pin Molex connector: do NOT pull too hard or far on the battery pack or it will come unplugged and the unit returned to WET Labs.

9. Gently pull the white cord at the loop to remove the battery pack from the pressure housing.
10. Remove the black plastic protectors from the ends of the long screws securing the batteries.
11. Loosen and remove the screws (3/16-in slotted driver).

4.2 Replacing End Flange and Batteries

1. Replace the batteries.
2. Re-install the screws:
 - Align the groove in each of the plates so the six-wire extension bundle will fit in it along its length.
 - Be careful not to cross-thread into the bottom end plate nor to over-tighten the screws.
 - If they are too tight, the fiber washers that act as separators between the batteries will flex.
 - Make sure there are equal amounts of screw threads protruding from the bottom end plate when they are secure. This will ensure the pack is straight and will fit into the pressure housing with no difficulty.
3. Re-install the black plastic protective covers on the ends of the screws.
4. Remove and check the pressure housing O-ring for nicks or tears. Replace if necessary. Before re-installing, apply a light coat of vacuum grease on the O-ring.
5. Carefully replace the battery pack in the pressure housing. Place the neoprene insulator on the battery assembly and lay the white cord on the top.
6. Plug in the two-pin, then the six-pin Molex connectors. Sensor operation can now be tested if desired.
7. Align the hole in the end flange (NOT the jack screw holes) with the white dowel pin. While coiling the six wire bundle and making sure none are pinched between the end flange and the pressure housing, position the flange on the housing. Leave space to re-insert the gray foam spacer, making sure the cut-out accommodates the vent plug screw.
8. Push the end flange all the way on to the pressure housing, making sure no wires are pinched. Be sure the vent plug does not pop up. If it does, you'll need to re-position the foam spacer.
9. Re-insert the monofilament.

4.3 Checking Vent Plug

If there is fouling on the vent plug, it should be cleaned and the two 010 O-rings replaced. Otherwise, this mechanism should be maintenance-free.

WARNING!

The pressure housing is made of plastic material that scratches easily. Do not let the screwdriver slip and scratch the can when removing or replacing the vent plug. Use a toothpick (something softer than the plastic) to remove the O-rings from the vent plug.

1. Pull vent plug out about half way; hold plug while unscrewing the truss screw. When screw is removed, pull vent plug from end flange.
2. “Pinch” bottom O-ring around vent plug to form a small gap you can work a toothpick into. Use the toothpick to help roll the bottom O-ring off the plug.
3. Perform the same procedure with the top O-ring.
4. Clean the vent plug and vent plug hole using a dry lint-free tissue or cotton swab.
5. Lightly coat two undamaged or new O-rings with silicon grease. Install the top O-ring (nearest to large end of plug) first, then the bottom one.
6. Insert vent plug into its hole in the end flange and hold it while inserting the truss screw. Rotate the vent plug to begin tightening the screw. Finish tightening using a screwdriver, being careful not to overtighten truss screw.

Note

A portion of the truss screw head has been removed to allow for venting in case of pressure buildup.

5. Data Analysis

Raw data from the BB is output as counts from the sensor, ranging from 0 to 4120 ± 5 . After the sensor is calibrated (i.e., subtracting the dark offset and multiplying by scaling factor—see Section 6), this data is now in the meaningful form of volume scattering coefficients, $\beta(\theta, \lambda)$ with units of $\text{m}^{-1} \text{sr}^{-1}$, where θ is angle and λ is wavelength. The ECO host program will automatically perform the necessary calculations. Refer to the ECOView User's Guide for details of data collection.

5.1 Data Corrections

Attenuation coupling—For the population of photons scattered within the remote sample volume in front of the sensor face, there is attenuation along the path from the light source to the sample volume to the detector. This results in the scattering measurements being underestimates of the true volume scattering in the hydrosol. Corrected volume scattering coefficients can be obtained by accounting for the effect of attenuation along an average pathlength. This average pathlength was numerically solved in the weighting function determinations developed by Dr. Ron Zaneveld that are used in the calibration procedures.

Since the calibration of the BB uses microspherical scatterers, the component of attenuation that can be attributed to scattering is incorporated into the scaling factor, i.e., the calibration itself. Thus, only absorption of the incident beam needs to be included in the correction.

The dependence on absorption, a , is determined as follows, where the measured scattering function at a given value of a , $\beta_{\text{meas}}(\text{angle}, a)$, is corrected to the value for $a = 0 \text{ m}^{-1}$, $\beta_{\text{corr}}(117^\circ, a=0)$:

$$\beta_{\text{corr}}(117^\circ, a=0) = \beta_{\text{meas}}(117^\circ, a) \exp(0.0391a)$$

Absorption can be measured with an ac-9 device. For each ECO-BB wavelength, the matching absorption coefficient must be used from the ac-9. Because the ECO-BB incorporates short pathlengths and relatively small scattering volumes in its measurements, this attenuation error is typically small, about 4 percent at $a = 1 \text{ m}^{-1}$.

Temperature correction—Output from an LED reference detector is provided, which gives an indication of relative LED intensity during operation. Work is presently under way to incorporate this signal as an ongoing correction for measurements. Largest expected deviations in the calibration coefficients are about 10 percent in the temperature range 0–28 degrees C. Note that these errors become more pronounced for very clear waters. If the instrument is planned for use in clear water environments at the ends of this temperature range, it is recommended that a request be made for calibration data to be collected as close to the expected environmental temperature as possible.

5.2 Derived Parameters

5.2.1 Volume Scattering of Particles

The corrected volume scattering of particles, $\beta(117^\circ, \lambda)$ values represent total volume scattering, i.e., scattering from particles and molecular scattering from water. To obtain the volume scattering of particles only, subtract the volume scattering of water, $\beta_w(117^\circ, \lambda)$:

$$\beta_p(117^\circ, \lambda) = \beta(117^\circ, \lambda) - \beta_w(117^\circ, \lambda)$$

where $\beta_w(117^\circ, \lambda)$ is obtained from the relationship (from Morel 1974):

$$\beta_w(\theta, \lambda) = 1.38(\lambda/500\text{nm})^{-4.32}(1+0.3S/37)10^{-4} (1+\cos^2\theta(1-\delta)/(1+\delta))\text{m}^{-1}\text{sr}^{-1}, \delta=0.09$$

where S is salinity.

For total scattering of pure water,

$$b_w(\lambda) = 0.0022533 (\lambda/500\text{nm})^{-4.23}.$$

For total scattering of seawater (35–39 ppt),

$$b_{sw}(\lambda) = 0.0029308 (\lambda/500\text{nm})^{-4.24}.$$

For backscattering by water, divide b_w or b_{sw} by 2. The units for the b coefficients are (10^{-4} m^{-1}).

5.2.2 Backscattering Coefficients

Particulate backscattering coefficients, $b_{bp}(\lambda)$ with units of m^{-1} , can be determined through estimation from the single measurement of $\beta_p(117^\circ, \lambda)$ using an X factor:

$$b_{bp} = 2\pi X \beta_p(117^\circ)$$

From measurements of the volume scattering function with high angular resolution in a diversity of water types, Boss and Pegau (2001) have determined X to be **1.1** (Boss, E., and S. Pegau, 2001. The relationship of scattering in an angle in the back direction to the backscattering coefficient, *Applied Optics*). This factor estimates b_{bp} with an estimated uncertainty of 4 percent. The conversion can be used for $\beta(117^\circ)$ measurements made at any visible wavelength.

To compute total backscattering coefficients, $b_b(\lambda)$ with units of m^{-1} , the backscattering from pure water, $b_{bw}(\lambda)$ (see Table above), needs to be added to $b_{bp}(\lambda)$:

$$b_b(\lambda) = b_{bp}(\lambda) + b_{bw}(\lambda).$$

6. Calibration and Testing

Each *ECO* is calibrated and tested to ensure that it meets the instrument's stated specifications. The *ECO-BB* is typically configured for a measurement range of 0–5 m^{-1} (red), and 0–10 m^{-1} (blue or green). This is done by setting several gain settings inside the instrument and running a pure water blank to determine the zero voltage offset and to ensure that the dynamic range covers the measurement range of interest. As is the case with other scattering meters, you must perform a detailed calibration to determine the actual zero point and scale factor for your particular use.

6.1 Calibration

Each meter ships with a calibration sheet that provides instrument-specific calibration information, derived from the steps below.

1. For a given scattering centroid angle (θ_c), compute the weighting function $W(\theta, \theta_c)$, by numerical integration of sample volume elements according to the sensor geometry.
2. Determine scattering phase functions, $\beta(\theta, \lambda)/b(\lambda)$, for the polystyrene bead microsphere calibration particles by weighting volume scattering functions computed from Mie theory according to the known size distribution of the polystyrene bead microsphere polydispersion and normalizing to total scattering.
3. By convolving $W(\theta, \theta_c)$ with $\beta(\theta, \lambda)/b(\lambda)$, compute the normalized volume scattering coefficient for each measurement angle, $\beta(\theta_c)/b$, with units of sr^{-1} for 2.00-micron diameter polystyrene bead microspheres.
4. Experimentally obtain raw scattering counts simultaneously with attenuation coefficients (C_p , using an ac-9) for a concentration series of the polystyrene bead microsphere polydispersion. Absorption by the calibration particles is assumed negligible.
5. Obtain b/counts from the slope of a linear regression between C_p (equivalent to b for the beads) and counts.
6. Multiplying the experimental b/counts by the theoretical $\beta(\theta_c)/b$ yields the calibration scaling factor, SF.
7. To obtain $\beta(\theta_c)$, subtract the dark counts from the raw counts measured, then multiply by SF.
8. This test also provides a measure of the inherent opto-electronic noise level of the instrument. A standard deviation from the average number of counts on a 1 minute data file is taken. This is translated into the resolution of $\beta(\theta_c)$ (minimum detectable signal change) in units of $\text{m}^{-1} \text{sr}^{-1}$.

Definitions of Terms

<p>β: phase function θ: angle W: weighting function C_p: particulate attenuation coefficient m^{-1}: per meter</p>	<p>b: total scattering coefficient θ_c: centroid angle λ: wavelength SF: Scaling Factor sr^{-1}: per steradian</p>
---	---

6.2 Testing

When the instrument is completely assembled, it goes through the tests below to ensure performance.

6.2.1 Dark Counts

The meter's baseline reading in the absence of source light is the dark count value. This is determined by measuring the signal output of the meter in clean, de-ionized water with black tape over the detector.

6.2.2 Pressure

To ensure the integrity of the housing and seals, *ECOs* are subjected to a wet hyperbaric test before final testing. The testing chamber applies a water pressure of at least 50 PSI.

6.2.3 Mechanical Stability

Before final testing, the *ECO* is subjected to a mechanical stability test. This involves subjecting the unit to mild vibration and shock. Proper instrument functionality is verified afterwards.

6.2.4 Electronic Stability

This value is computed by collecting a sample once every five seconds for twelve hours, or more. After the data is collected, the standard deviation of this set is calculated and then divided by the number of hours the test has run. The stability value must be less than 2.0 mV/hour.

6.2.5 Noise

Noise is computed from a standard deviation over 60 samples, collected at one-second intervals for one minute. The standard deviation is calculated on the 60 samples, and the result is the published resolution on the calibration sheet. The calculated standard deviation value must be below 2 counts.

6.2.6 Voltage and Current Range Verification

To verify that the *ECO* operates over the entire specified voltage range (7–15V), a voltage-sweep test is performed. *ECO* is operated over the entire voltage range, and the current and operation is observed. The current must remain constant at approximately 85 mA over the entire voltage range.

7. Terminal Communications

As an alternative to the ECOView Host software, *ECO* sensors can be controlled from a terminal emulator or customer-supplied interface software. This section outlines hardware requirements and low-level interface commands for this type of operation.

7.1 Interface Specifications

- baud rate: 19200
- data bits: 8
- parity: none
- stop bits: 1
- flow control: none

7.2 Command List

Command	Parameters passed	Description
!!!!	none	Stops data collection; allows user to input setup parameters. Note that if the meter is in a sleep state, the power must be turned off for a minute, then powered on while the “!” key is held down for several seconds. If this does not “wake” the meter, refer to the ECOView user’s guide Operation Tip to “wake” a meter in a low power sleep state to enable inputting setup parameters.
\$save	single number, 1 to 65535	Number of measurements for each reported value
\$clk	24hr format time, hhmmss	Sets the time in the Real Time Clock
\$dat	date, format ddmmyy	Sets the date in the Real Time Clock
\$emc	none	Erases the Atmel memory chip, displays menu when done
\$get	none	Reads data out of Atmel memory chip. Prints "etx" when completed.
\$int	24hr format time, hhmmss	Time interval between packets in a set
\$mnu	none	Prints the menu, including time and date
\$pkt	single number, 0 to 65535	Number of individual measurements in each packet
\$rec	1 (on) or 0 (off)	Enables or disables recording data to Atmel memory chip
\$rls	none	Reloads settings from flash
\$run	none	Executes the current settings
\$set	single number, 0 to 65535	Number of packets in a set
\$sto	none	Stores current settings to internal flash

8. Device Files

Each meter is shipped with a CD containing the meter-specific device file, a sample output file, characterization information, and the applicable user’s guides.

The ECOView host program requires a device file to provide engineering unit outputs for any of its measurements. Except for the first line in the device file, all lines of information in the device file that do not conform to one of the descriptor headers will be ignored. Every ECOView device file has three required elements: Plot Header, Column Count Specification, and Column Description.

8.1 Plot Header

The first line in the device file is used as the plot header for the ECOView plots.

8.2 Column Count Specification

The Column Count Specification identifies how many columns of data to expect. It follows the format “Column=n.” The Column Count Specification must be present before any of the Column Descriptions are listed.

8.3 Column Description

Every column in the ECO meter’s output must have a corresponding Column Description in the device file. The following notation is used in identifying the elements of each Column Description.

- x = the column number, starting with 1 as the 1st column
- sc = scale
- dc = dark count: meter output in clean water with optics head taped
- mw = wavelength measured by the sensor
- dw = display wavelength—color to plot the BB data in
- v = measured volts dc

Valid Column Descriptions are listed in the subsections below.

8.3.1 Scattering Measurements

Lambda=x sc dc mw dw Scatter sensor column

8.3.2 Miscellaneous

Date=x DD/MM/YY
 Time=x HH:MM:SS
 N/U=x Not used; displays the meter’s as-built wavelength
 N/U=x Not used

There are several defaulted parameters ECOView uses in scatter calculations for BB meters:(a) salinity; (b) water type, fresh- or seawater; (c) Chi ; and (d) theta, the measurement angle. The user may change these using the following device file elements (the values shown are the defaults).

Salinity=32 32 ppt
 Water=Sea Meter is assumed to be in salt water (Use "Pure" for fresh water)
 XFactor=1.1 X Factor Correction Value
 Theta=117 Backscattering angle

8.4 Sample Device Files

8.4.1 Firmware Version 3.01 and Higher

Below is the standard device file for an ECO BB at 532 nm.

```
ECO BBS-309G
Created on: 10/24/07

Columns=5
Date=1
Time=2
N/U=3
Lambda=4      9.056e-06   67.1   532   532
N/U=5
```

8.4.2 Firmware Versions Prior to 3.01

```
ECO BBS-309G
Created on: 10/24/02

Columns=5
Date=1
Time=2
REF=3
Lambda=4      9.056e-06   67.1   532   532
N/U=5
```

8.5 Sample Output Files

The reference column is unused by both firmware versions, but in 3.01 the scattering wavelength of the signal is displayed.

8.5.1 Firmware Versions 3.01 and Higher

Date	Time	λ	Sig	Therm
02/19/08	13:56:28	532	1211	541
02/19/08	13:56:29	532	1225	540
02/19/08	13:56:30	532	1230	540
02/19/08	13:56:31	532	1200	540
02/19/08	13:56:32	532	1191	539

8.5.2 Firmware Versions Prior to 3.01

Date	Time	Ref	Sig	Therm
02/19/07	13:56:28	1752	1211	541
02/19/07	13:56:29	1739	1225	540
02/19/07	13:56:30	1732	1230	540
02/19/07	13:56:31	1728	1200	540

Appendix A: Mounting Bracket Drawing

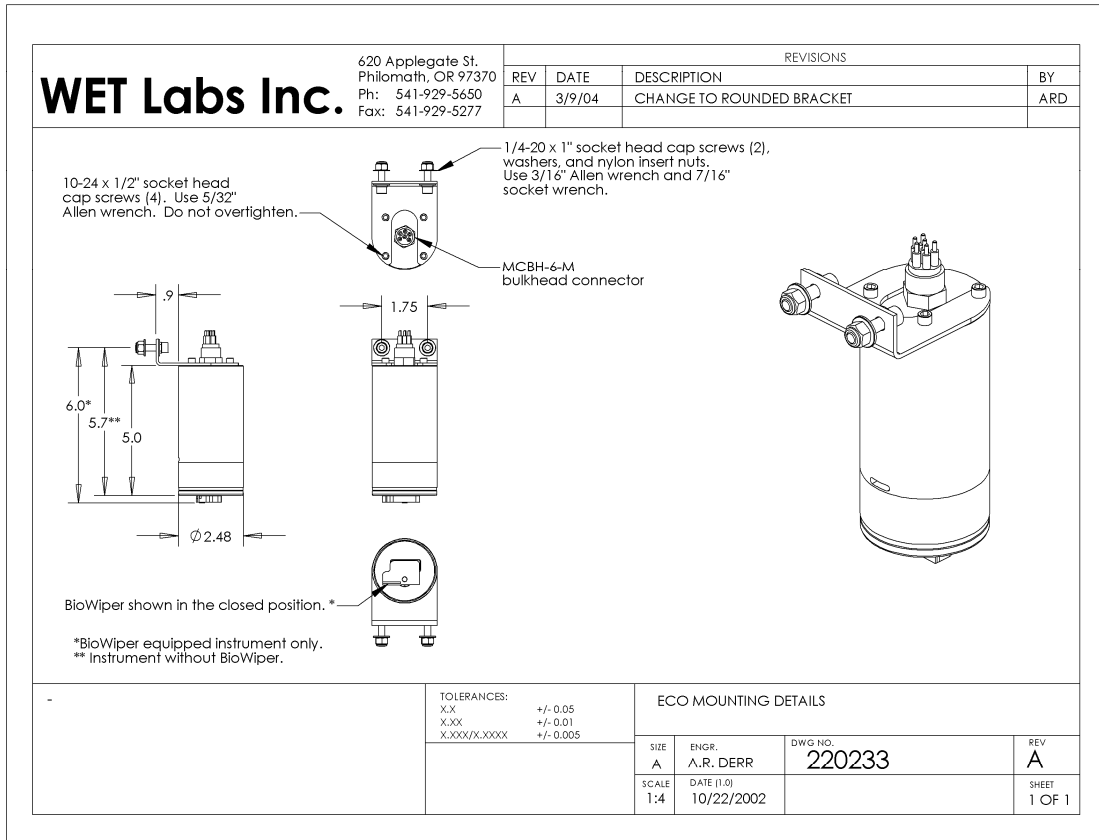

Revision History

Revision	Date	Revision Description	Originator
A	10/16/02	New document (DCR 242)	W. Strubhar, D. Whiteman
B	10/23/02	Add mounting bracket hardware description (DCR 251)	A. Derr
C	11/12/02	Add analog capability for (RT) models (DCR 254)	I. Walsh
D	2/10/03	Delete lithium battery warning (DCR 272)	D. Whiteman
E	2/24/03	Change "shutter" to "bio-wiper™" (DCR 280)	H. Van Zee
F	3/3/03	Add Terminal Communications section (DCR 283)	I. Walsh
G	4/14/03	Add stop command to terminal communications (DCR 292)	W. Strubhar
H	5/29/03	Clarify equations in section 5.2.1 (DCR 303)	M. Twardowski
I	8/6/03	Add to deliverables list, correct references in Data Analysis, update device files (DCR 321)	H. Van Zee
J	9/8/03	Add Scaling Factor derivation to Calibration Section (DCR 332)	D. Hankins, H. Van Zee, I. Walsh
K	11/24/03	Modify explanation for stop data collection command (DCR 342)	W. Strubhar
L	11/25/03	Update specifications (DCR 338)	I. Walsh
L1	2/3/04	Add device file change for optional pressure/temperature sensor	I. Walsh
M	2/5/04	Correct salinity value (DCR 365)	I. Walsh, D. Romanko
N	2/17/04	Update to neoprene bio-wiper blade (DCR 367)	A. Derr, I. Walsh
O	3/10/04	Add new test cable description, operational description, mounting diagram (DCR 381)	A. Derr, D. Whiteman
P	5/11/04	Remove pin 6 from warning in section 1 (DCR 390)	I. Walsh
Q	6/29/04	Update specifications (DCR 400)	I. Walsh
R	9/28/04	Add text for optional thermistor and pressure sensor (DCR 429)	I. Walsh
S	10/14/04	Add references to Lithium batteries for applicable models (DCR 433)	I. Walsh
T	7/26/05	Replace Clean Water Offset with Dark Counts (DCR 468)	M. Johnson
U	12/8/05	Add fluorescent stick, correct output file (DCR 477)	H. Van Zee
V	1/13/06	Clarify warranty statement (DCR 481)	A. Gellatly, S. Proctor
W	3/3/06	Add copper faceplate option (DCR 490, ECN 217)	H. Van Zee, I. Walsh
X	5/31/06	Add recommendation for annual maintenance (DCR 498)	S. Proctor
Y	6/28/06	Cleaning and maintenance of modified bio-wiper (ECN 230, DCR 502)	A. Derr, H. Van Zee
Z	7/27/06	Change length of securing screw on bio-wiper (ECN # not assigned; DCR 504)	J. da Cunha, H. Van Zee
AA	9/26/06	Update specifications (DCR 507)	M. Johnson
AB	11/01/06	Correct pressure sensor and thermistor output calculations (DCR 509)	M. Johnson
AC	9/11/07	Delete reference to refilling pressure sensor, update shipping requirements (DCR 531)	M. Johnson, H. Van Zee
AD	3/6/08	Change unused reference column to display as-built scattering wavelength (ECN 287; DCR 567)	M. Johnson
AE	7/10/08	Change dark counts derivation to reflect current production methodology (DCR 600)	A. Barnard, M. Johnson, H. Van Zee
AF	1/5/10	Change red LED wavelength, optical face angle dwg (DCR 685)	M. Johnson, H. Van Zee
AG	1/21/10	Admin change to organization (DCR 692)	H. Van Zee